

# IO-NET Programmable Control System.

## A Product Overview

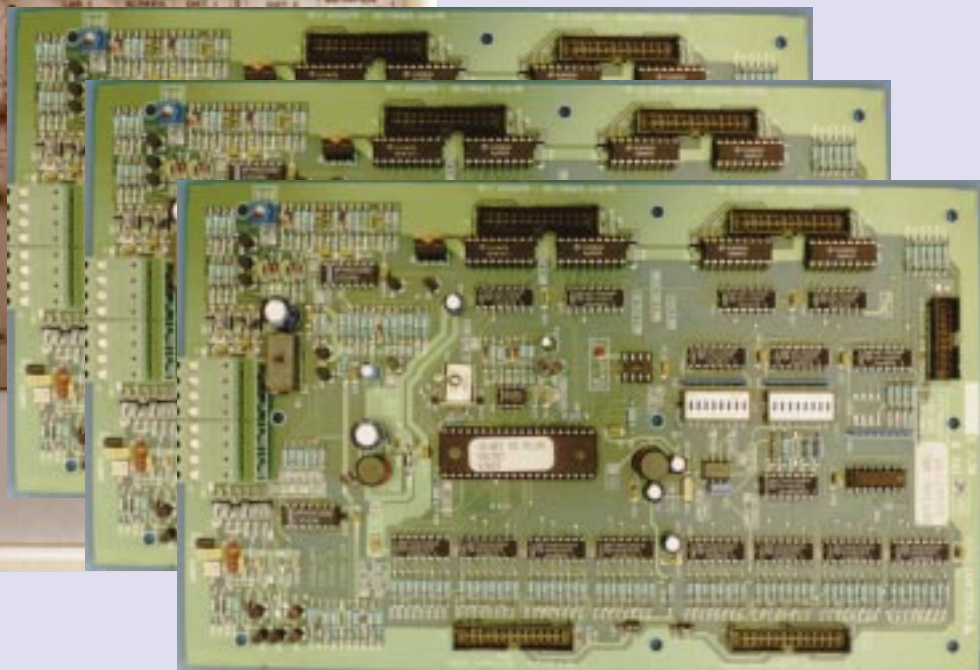

# IO-NET Programmable Control System

## Description

IO-NET is a low cost, distributed, field programmable control system that combines flexible control with networking communication facilities. It handles small or large numbers of inputs and/or outputs, whether concentrated at a single location or distributed over a wide area. All inputs are multi-level and can therefore provide the line supervision of input wiring often required for alarm applications. In addition, the IO-NET Controller can receive high level communications from a fire alarm system and use that information as additional input conditions for control logic. This combination of features makes IO-NET suitable for a wide range of control and telemetry applications: e.g. Alarm monitoring, AS 1668 Fire Fan Control, Mimic display of alarms, PLC with remote indication, Point-to-point telemetry, Remote annunciation, Stand-alone PLC.

IO-NET uses a proprietary, token-passing bus communication protocol that ensures efficient network operation. Peer to peer communication is easily achieved as no "master" station is required to control network traffic. The network continues to function quickly even when the volume of information to be transmitted is high. A 2 wire (data only) or a 3 wire (data and power supply), multi-dropped connection is the standard IO-NET system communications medium without special cables. Data speeds are selectable from 1200 to 9600 baud. RS485, modem, radio, and fibre optic communications may also be used.

An IO-NET System consists of at least one Controller. The Controller is connected to Termination Boards using flat ribbon cable looms. If connection to fire indicator panel communications is required then a RZDU to RS232 interface is also needed.

## Features

- 32 Inputs on each Controller.
- Each input common 0V, clean contacts, end-of-line resistor supervised.
- Inputs (in programmed mode) are multi-level: Open Circuit, Normal, Alarm, Short Circuit.
- 32 Outputs on each Controller. Open collector closure to 0V: 30 volts, 100 mA max.
- High level link compatible with Vigilant fire

indicator panel Remote Zone Display Unit (RZDU) protocol.

- Supervised cable connection to Input and Output Termination Boards.
- Controller operating voltage 17.5 - 28 volts dc.
- Controller current 6.5 mA plus 0.3 mA for every open collector output turned on (plus connected load).
- Programmed and unprogrammed modes.
- Readily programmed on-site or off-site using a personal computer and a small programming unit.
- Programmable parameters stored in non-volatile PROM which can be reprogrammed several times (depending on program size).
- Data Transmission: multidrop line driver switching 0 to 24 volts. RS485, modem and fibre optic link also available.
- Communication cable length: 3km @ 2400 baud, 1 km @ 9600 baud using multidrop line driver transmission, longer with modems.
- Controller address: 0 to 31 - unprogrammed mode (32 Controllers). 0 to 127 - programmed mode (128 Controllers).
- Communication baud rates: 1200, 2400, 4800, 9600.
- 16 & 32 Way Protected Input Termination Boards (exclude FRC Loom).
- 16 & 32 Way Protected Output Termination Boards (exclude FRC Loom).
- 16 Way Relay Board (includes FRC Loom).
- FRC Looms from 0.25 to 5m.
- Optional cabinet: 494W x 449H x 82D.
- Optional gear plate, pre-drilled for Controller and Termination or Relay Boards.

## Typical Applications

- √ Alarm monitoring,
- √ AS 1668 Fire Fan Control,
- √ Mimic display of alarms,
- √ PLC with remote indication,
- √ Point to point telemetry,
- √ Remote annunciation,
- √ Stand alone PLC

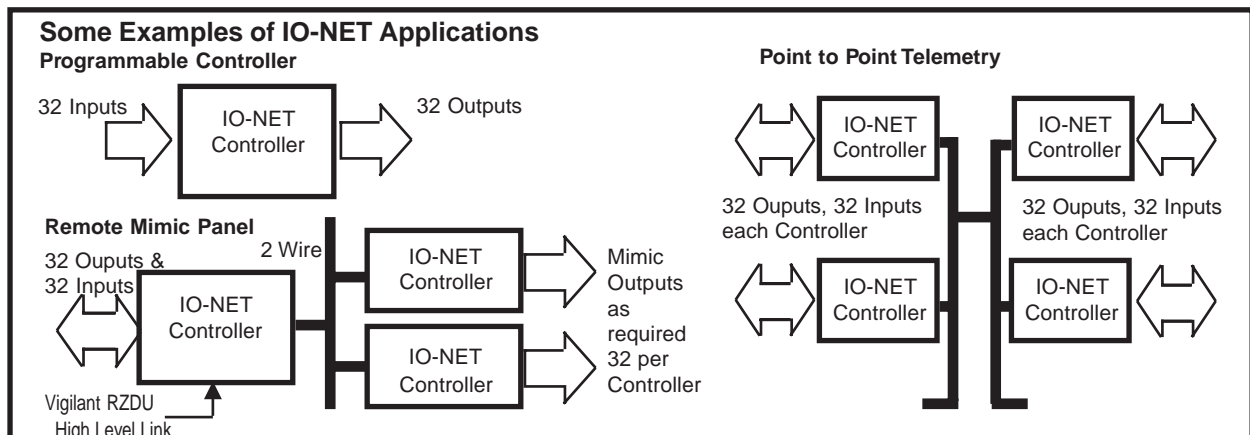

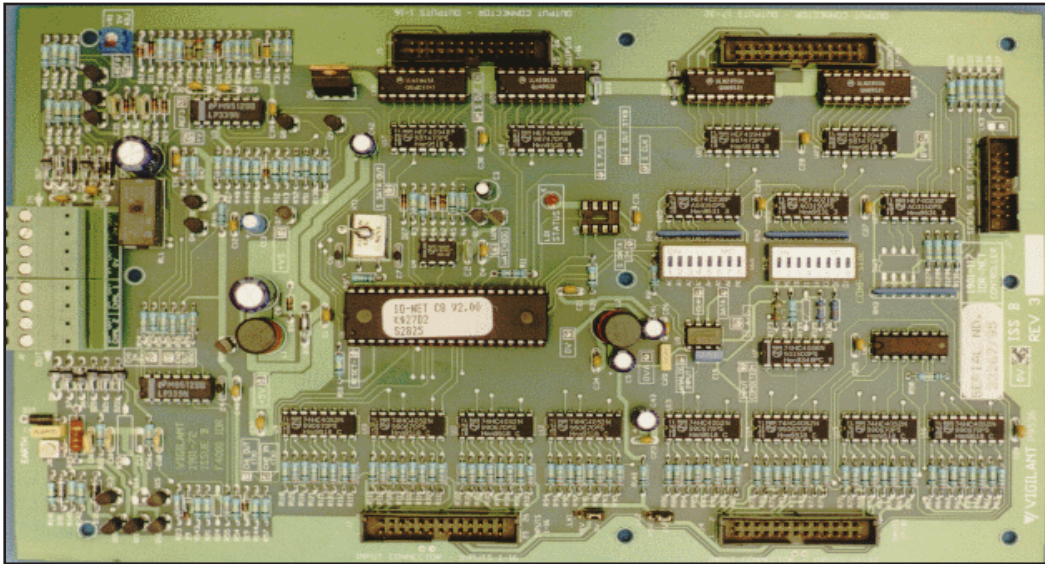

IO-NET Controller PA0498

## IO-NET Controller

Each IO-NET Controller has 32 digital inputs and can provide up to 32 programmable outputs. From this starting point the system can be expanded up to a maximum of 128 Controllers on one IO-NET communications line (although physical constraints may limit a system to less than this). At least 32 Controllers can be supported on a 1mm<sup>2</sup> line up to 3 km long.

Each Controller also supports a high level (Remote Zone Display Unit) input link from a compatible Vigilant fire alarm system. This makes the locally connected fire alarm system zone states available to the output logic of that Controller. In addition, the data from the high level input link of up to eight Controllers can be sent over the IO-NET system and so made available to the output logic of all other Controllers.

Without programming (apart for setting address switches) up to 32 IO-NET Controllers can function as a point to point telemetry system enabling the status of individual inputs to be transferred to outputs over a pair of wires. This means that for this application up to 512 inputs at one point (16 Controllers) can be repeated as 512 outputs at a second point, while at the same time 512 inputs at the second point can be repeated at the first point. Alternatively the Controllers could be distributed throughout a site. In this case each Controller would send its input state to, and receive its output state from one other Controller. This unprogrammed mode of operation is selected by a dip-switch on each Controller.

Powerful programmable control may be achieved on each IO-NET Controller by selecting the programmed mode of operation. The conditions of all remote, local and high level inputs in a system are available to programmable Boolean logic expressions. Logic expressions may include local

Timer status, Variables, Output Status, Controller and Network Status as well as local and global input status. Complex functions make operations such as change-of-state annunciation, and others possible. The logic expressions and parameters for specific outputs, timers and variables are stored in a nonvolatile, low-cost PROM on the corresponding IO-NET Controller. All Controllers in a Programmed IO-NET System do not need to operate in Programmed Mode. Controllers operating in Unprogrammed Mode can be used to gather input conditions provided no outputs are used.

The IO-NET PROM programming process is quickly accomplished either on-site or off-site using a personal computer and a small programming unit. The PROM is inserted into the programming module. Logic equations are typed into the computer and saved as a text source file. A compiler program, operating on the PC, generates the program file and downloads it into the PROM. If program size permits, each PROM may be reprogrammed several times before it becomes full and must be replaced.

To assist with IO-NET system setup and trouble shooting, a diagnostics program is provided with the IO-NET programming unit and compiler. This enables the system data to be viewed on a personal computer.

The IO-NET Controller is a single printed circuit board. Demountable terminals for the power supply connection (24 volts dc) and the serial data communications are located at one end of the board. Input and output plug-in connectors are located on each side of the board. These must be connected to separate termination boards using flat ribbon cable looms.

Part No	Dim. (mm)	ShipWt
PA0498	270 x 165 x 25	310 g.

# IO-NET System Components

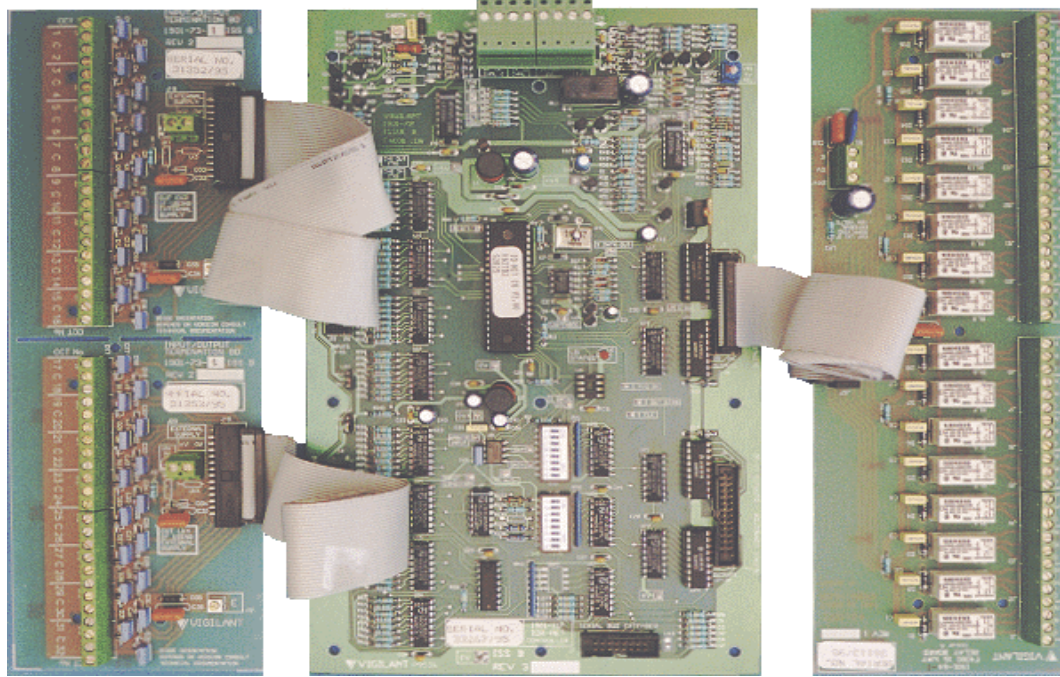

32 Input Protected Termination Board

Controller

16 Way Relay Board

## 16 & 32 Input Protected Termination Boards

The 16 Input and 32 Input Protected Termination Boards are used for connecting field wiring to the IO-NET Controller. These termination boards include transient suppression components to protect the IO-NET inputs from electrical transients. They must be used to terminate all IO-NET Controller input cabling that extends beyond the IO-NET enclosure.

Cable Termination Capacity: 1.5 sq mm max.

Part No	Dim. (mm)	ShipWt
PA0479 (16 Way)	135 x 93 x 23	100 g.
PA0474 (32 Way)	270 x 93 x 23	200 g.

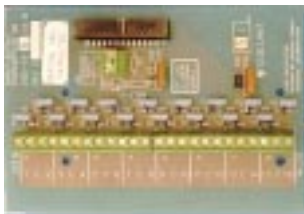

16 Input Protected Termination Board, PA0479

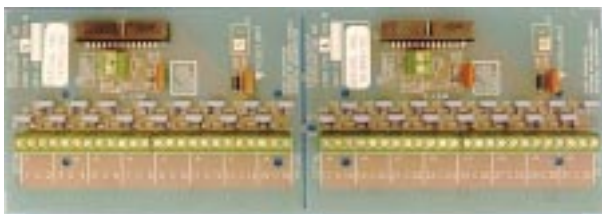

32 Input Protected Termination Board, PA0474

## 16 & 32 Output Protected Termination Boards

The 16 Output and 32 Output Protected Termination Boards are used for connecting field wiring to the IO-NET Controller. These termination boards include transient suppression components to protect the IO-NET inputs from electrical transients. They must be used to terminate all cabling that connects directly to IO-NET Controller outputs and extends beyond the IO-NET enclosure.

Cable Termination Capacity: 1.5 sq mm max.

Part No	Dim. (mm)	ShipWt
PA0480 (16 Way)	135 x 93 x 23	100 g.
PA0475 (32 Way)	270 x 93 x 23	200 g.



16 Output Protected Termination Board, PA0480

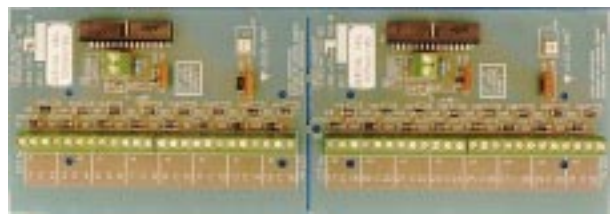

32 Output Protected Termination Board, PA0475

## Unprotected Termination Boards

Unprotected Termination Boards are small printed circuit boards providing direct screw terminations for 16 inputs or 16 outputs of an IO-NET Controller. No transient protection is provided so these boards should only be used where the wiring is not extended beyond the IO-NET Controller enclosure. Typical uses include connection of mimic lamps and control panel switches to an IO-NET Controller. A version of this board is available for connection to LEDs without their own current limiting. The current limiting 3k3 series resistors set the current to approximately 7 mA from 24Vdc. High efficiency LEDs must be used.

Cable Termination Capacity: 1.5 sq mm max.

Part No	Dim. (mm)	ShipWt
PA0483 (no resistors)	69 x 46 x 18	100 g.
PA0769 (c/w resistors)	69 x 46 x 18	100 g.

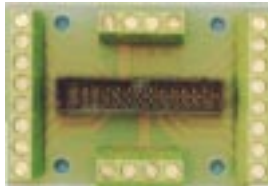

16 Way Unprotected Termination Board, PA0483

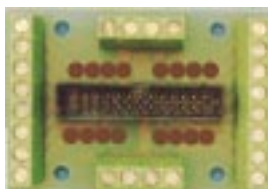

16 Way Unprotected Termination Board c/w Resistors, PA0769

## Termination Board Looms

Each termination board requires a Flat Ribbon Cable (FRC) loom to enable it to be connected to the Controller. Looms are available in a variety of lengths as listed below.

Part No	Length (m)	ShipWt
LM0049	0.25	20 g.
LM0046	0.5	30 g.
LM0056	1.4	70 g.
LM0044	2.0	95 g.
LM0045	5.0	220 g.



Loom, 0.5 metre FRC, LM0046

## 16 Way Relay Board

The 16 Way Relay Board has the same physical dimensions and footprint as the 32 Way Protected Termination Board. It comes complete with a 1.4 metre flat ribbon cable for connection to one of the IO-NET output connectors.

Relay Coil Current: 12 mA at 24 volts.

Contact Configuration: Single pole changeover.  
30V, 2A resistive, 1A inductive.

Cable Termination Capacity: 1.5 sq mm max.

Part No	Dim. (mm)	Ship Wt
PA0470	270 x 93 x 25	350 g.

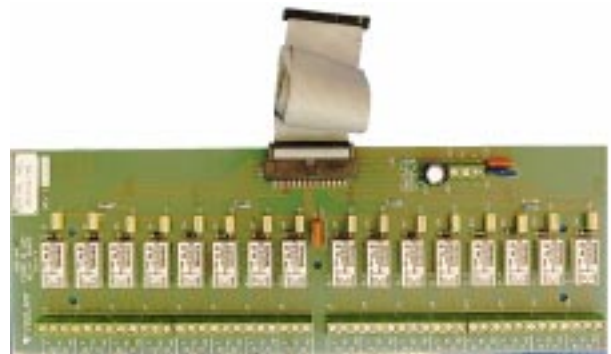

16 Way Relay Board, PA0470

## RZDU to RS232 Interface

The RZDU to RS232 Interface is a small printed circuit board that converts Remote Zone Display Unit serial communications from a fire indicator panel into RS232 compatible signals. This module is required for an IO-NET Controller to receive information from a compatible Vigilant fire alarm panel.

Operating Voltage: 17 to 30 volts dc.

Current: 5 mA.

Part No	Dim. (mm)	Ship Wt
PA0481	104 x 72 x 23	100 g.



RZDU to RS232 Interface, PA0481

## RS485/ Fibre Optic/Radio Interface

This uses non-proprietary items therefore consult distributor.

# IO-NET System Components

## 1200 Baud Modem

The 1200 Baud Modem is an optional component of an IO-NET system. It is required for IO-NET data communications over non-metallic media or over telecommunications circuits where Austel approval is required or for communication over long distances. Refer to the User Manual for the details of wiring between the Modem and the Controller.

Voltage: 5 volts dc (from IO-NET Controller)

Current: 15 mA

Austel permit A94/37D/0100

Part No	Dim. (mm)	Ship Wt
PA0464	130 x 49 x 23	100 g.



1200 Baud Modem, PA0464

## IO-NET Gear Plate

The IO-NET gearplate is predrilled with mounting holes for an IO-NET Controller and Termination Boards or 16 Way Relay Boards. It provides a convenient method of mounting IO-NET hardware within a rack cabinet or other enclosure. The printed circuit boards are mounted on the gearplate using nylon push-on printed circuit board standoffs (part no HW0130). The space at the top of the gear plate has mounting holes for a 24 volt power supply (FP0474), or alternatively another termination board (e.g. second 16 Way Relay Board) can be mounted horizontally.

Material: 1.6 mm mild steel.

Finish: Zinc plated & colour passivated.

Part No	Dim. (mm)	Ship Wt
FA1185	430 x 450 x 10	2.3 kg.

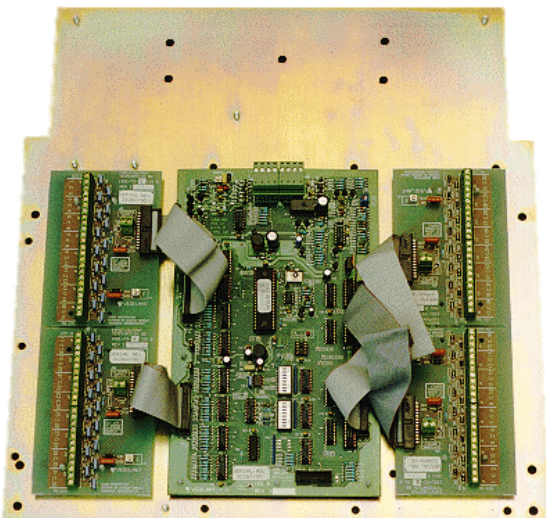

IO-NET Gear Plate, FA1185

## IO-NET Cabinet

The IO-NET Cabinet is capable of containing the following arrangements:

1 x IO-NET Controller plus 3 x 32 Way Termination Boards or 16 Way Relay Boards

2 x IO-NET Controllers plus 5 x 32 Way Termination Boards or 16 Way Relay Boards. For this arrangement the Controllers are mounted on the inside of the door with adhesive standoffs (HW0208), with flat ribbon cabling across to the Termination Boards.

The cabinet part number ME0088 comes complete with a 003 cam lock (Australian standard) while ME0089 has a 60124 lock (NZ standard). A gear plate is not necessary for mounting IO-NET components in this cabinet. The back plate of each cabinet is pre-drilled with mounting holes to suit a variety of PCB mounting arrangements and is supplied with a quantity of loose PCB standoffs that can be fitted in the appropriate holes to suit the particular arrangement.

There is also space in the cabinet for a small mains power supply (PA0736) and standby battery.

Material: 1.0mm mild steel.

Finish: Baked epoxy powdercoat, Cream Wrinkle BFF998CW.

Protection Category: IP50; sealing can be added to increase protection to IP51.

Part No	Dim. (mm)	Ship Wt
ME0088 (003 lock)	494 x 449 x 82	4.8 kg.
ME0089 (60124 lock)	494 x 449 x 82	4.8 kg.

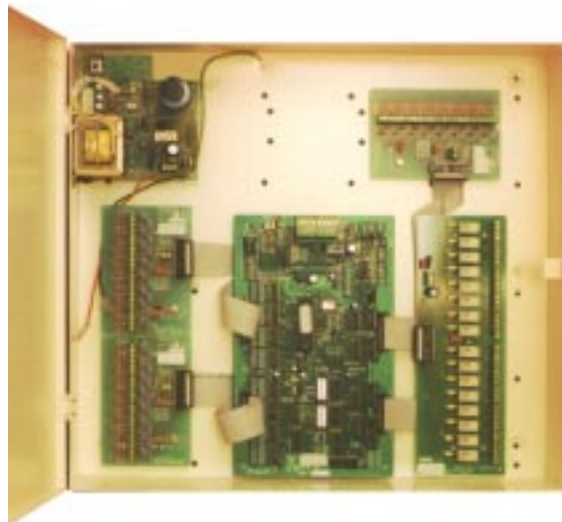

IO-NET Cabinet, ME0088 / ME0089

(Cabinet shown with Controller, 16 Way Relay Board, 16 Way Output Board, 32 Way Input Board, and Power Supply fitted. These items are *not* supplied with the Cabinet.)

## IO-NET Programming Unit

The IO-NET Programming Unit transfers the program to the IO-NET Controller PROMs. This process is required for a controller to operate in programmed mode. The Programming Unit is supplied complete with a cable to connect between the PC and the Programming Unit, the compiler programming software (for a PC), and the IO-NET User Manual. An external 24 volts dc supply is required (19.2 to 28.3 volts).

Complete instructions on how to program an IO-NET PROM are contained in the IO-NET User Manual and this should be read before any programming is carried out. Briefly the process is as follows:

Remove the PROM from the IO-NET Controller and insert it into the Programming Unit. Connect the Programming Unit to the serial port of the PC and to the 24 volts power supply. Generate (or edit) a text file containing the required logic equations on the PC, compile the text file using the programming software, then download it into the PROM in the Programming Unit. Turn off the power supply to the Programming Unit, remove the PROM and insert it back into the IO-NET Controller. The programming process is complete.



IO-NET Programming Unit, PA0700



Programming Lead, LM0041



IO-NET Compiler, SF0088



LT0115, IO-NET User

Part No	Dim. (mm)	Ship Wt
PA0700	180 x 240 x 50	700 g.
LM0041	2,000	80 g.
SF0088	90 x 94 x 3	20 g.
LT0115	230 x 325 x 7	450 g.

**Note:** The Programming Lead (LM0041), the IO-NET Compiler (SF0088) and the IO-NET User Manual (LT0115) are all included when Part No PA0700 (IO-NET Programming Unit) is ordered.

## IO-NET Controller PROM

This is a "blank" replacement microprocessor PROM for the IO-NET Controller. It comes already for use in the non-programmed mode operation of the IO-NET Controller, and has completely blank user program space for operation in programmed mode. A standard Controller PROM (part number SF0087) is supplied inserted into each IO-NET Controller, and, if program size permits, this PROM may be reprogrammed a number of times. Eventually the user program space will become full and a replacement PROM must then be obtained.

For applications where the program size is larger than normal, a PROM with more RAM and over 5 times more program storage capacity is available.

SF0087	IO-NET PROM, Standard memory
SF0139	IO-NET PROM, Larger memory



SF0087 IO-NET Controller PROM

## IO-NET System Components

### Other Products

Some of the other products that can be used with IO-NET are listed below.

**Modbus Bridge:** The Modbus Bridge is used to interface an IO-NET system with a Building Management System or other third party monitoring system. It makes the input status of all IO-NET Controllers and the zone status of any connected fire alarm panels available in the widely supported Modbus communications protocol.

Part No	Dim. (mm)	Ship Wt
FP0675	450 x 280 x 80	5.5 kg.

**Picture Frame Display Cabinet:** This is a low profile, metal cabinet with a lockable, front opening door. The door is covered by a translucent acrylic panel, making it an ideal enclosure for wall mounted mimic and/or control panels. Internal mounting arrangements are provided for up to four Mimic Display Boards and up to two IO-NET Controllers.

Part No	Dim. (mm)	Ship Wt
ME0073	550 x 440 x 58	5 kg.

**Mimic Display Board:** The Mimic Display Board contains 16 red LEDs positioned in line at 12.7 mm centres to provide index lamps for a mimic panel. Two versions of the board are available. PA0753 has 5mm LEDs that extend 25 mm so as to protrude through the acrylic door panel of the Picture Frame Display. PA0738 has shorter 3 mm LEDs and mounts behind a mimic panel with the LEDs visible through holes in the panel. Both PCBs connect directly to the output connectors on the IO-NET Controller via standard flat ribbon cables.

Part No	Dim. (mm)	Ship Wt
PA0738	248 x 98 x 16	100 g.
PA0753	248 x 98 x 28	100 g.

### System Part Numbers

FP0474	Power Supply, 24V, 2.5A
FP0675	Modbus Bridge
FA1185	IO-NET Gearplate
HW0130	PCB Standoff, 6.25 mm mounting
HW0208	PCB Standoff, adhesive base
LM0041	Programming Lead (included in PA0700)
LM0044	Loom, 2 metres
LM0045	Loom, 5 metres
LM0046	Loom. 0.5 metres
LM0049	Loom, 0.25 metres
LM0056	Loom, 1.4 metres
LT0115	IO-NET User Manual (included in PA0700)
ME0073	Picture Frame Display Cabinet
ME0088	IO-NET Cabinet (003 Lock)
ME0089	IO-NET Cabinet (60124 Lock)
PA0464	1200 Baud Modem
PA0470	16 Way Relay Board
PA0474	32 Input Protected Termination Board
PA0475	32 Output Protected Termination Board
PA0479	16 Input Protected Termination Board
PA0480	16 Output Protected Termination Board
PA0481	RZDU to RS232 Interface
PA0483	16 Way Unprotected Termination Board
PA0498	IO-NET Controller
PA0700	IO-NET Programming Unit
PA0736	Power Supply, 24V, 0.5A
PA0738	Mimic Display Board (3mm LEDs)
PA0753	Mimic Display Board (5mm LEDs)
PA0769	16 Way Unprot. Term. Bd c/w Resistors
SF0087	IO-NET Controller PROM (standard)
SF0088	IO-NET Compiler (included in PA0700)
SF0139	IO-NET Controller PROM (large mem.)

### IO-NET is a product of:

Vigilant Fire & Evacuation Systems  
211 Maces Road, Bromley  
Box 19-545  
Christchurch 8006  
New Zealand

### IO-NET is also available from: